

MILLENNIUM 7

AQUATIC

MILLENNIUM SERIES MODEL #A17MIL7257

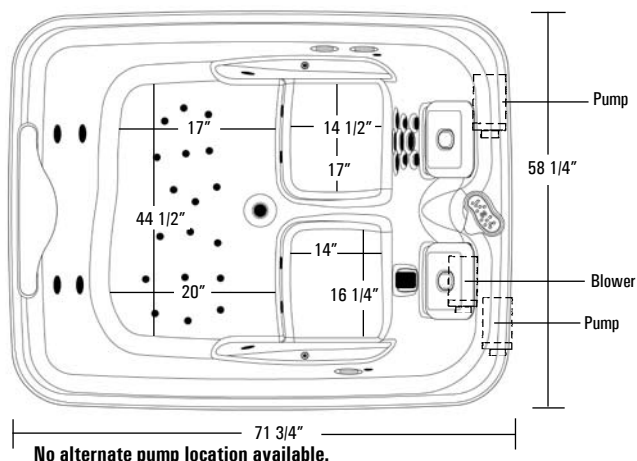

*Available without fast-fill waterfall spout.

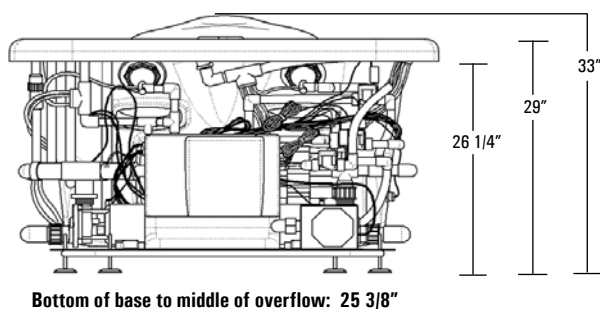

Rough-In Plumbing Measurements

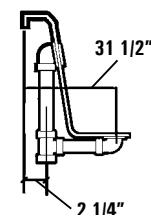

SPECIFICATIONS:

GENERAL SPECIFICATIONS:

Tub Size	71 3/4" x 58 1/4" x 33"
	182 cm x 148 cm x 84 cm
Bathing Well	44" long
	44 1/2" wide
	25 1/4" interior depth
	20 1/2" maximum water depth
Shipping Weight	685 lbs. / 311 kg
Tub Weight Filled	1870 lbs. / 848 kg
Gallons to Overflow	184 gal. / 697 L
Gallons to Operate	1 bather: 147 gal. / 556 L
	2 bathers: 128 gal. / 485 L

ELECTRICAL SPECIFICATIONS:

Electronic Control Package:
230V; 50 AMP w/ GFCI; 4-Wire w/ Dedicated Neutral

This unit is not recommended for shower installations.

This unit has a 3/4" female waterfall fill spout connection.

STANDARD EQUIPMENT:

- 24 Hydrotherapy Jets including:**
- 12 Shiatsu-Pro Neck and Back Jets
 - 2 Recessed Fan Jets
 - 4 Rotary Massage Foot Jets
 - 2 Rotary Massage Knee Jets
 - 2 Pressure Plus Wrist Jets and 2 Pressure Plus Elbow Jets
- Air Bath System:**
- 1 HP Variable Speed Air Blower with 20-Minute Timer
 - Automatic Purge and Dry Cycle
 - 600 Watt Air Heating System
- Aquatic Quality Features:**
- Independent 2 HP, 3-Speed Run-Dry Pumps
 - Digital Electronic Control System
 - Shiatsu Electronic Control with Preprogrammed Jet Sequencer
 - Waterproof Universal Remote Control
 - 4 kW Inline Maintenance Heater
 - 2 Pulsating Neck Jet Pillows
 - Integrally Molded Fast-Fill Waterfall Spout/Optional - please specify on order (valves not included)
 - Bi-level Foot Rest
 - Chromatherapy
 - 2 Reclining Lounge Seats with Arm Rests
 - Adjusta-Level Base
 - "Quiet Pad" Anti-Vibration Pump Mounts
 - Heat-bent Rigid PVC Piping for Optimum Sanitary Conditions
 - Slip Resistant Floor
 - Durable, Easy to Clean, Lucite® Cast Acrylic Surface
 - Available in 8 Standard No-Charge Colors
- UL & IAPMO Listed, Factory Tested Limited Lifetime Warranty**

OPTIONAL EQUIPMENT:

- Available without Fast-Fill Waterfall Spout - See Price List for Details
- Jet Finish
 - Chrome, Polished Brass, Gold, Polished Nickel or Satin Nickel
- Lift & Turn Waste and Overflow
 - Chrome, Polished Brass, Gold, Polished Nickel, Satin Nickel, or Oil Rubbed Bronze
- Cable Drive Waste and Overflow
 - Chrome, Polished Brass, Gold, Polished Nickel, Satin Nickel, Oil Rubbed Bronze, or Color Matched (Bone, White, and Biscuit Only)
- Hand Held Jet - Chrome or Polished Brass
- Premium Colors

All acrylic colors featured by Aquatic match the industry's leading fixture manufacturers.

Fax-On-Demand Document # 1192



The manufacturer accepts a 1/4" variance. There are variations on each tub and specifications are subject to change as we improve upon our product as required. The dimensions needed for site preparation and structure building should be measured from the tub; Aquatic Industries, Inc. assumes no responsibility for preparatory work.

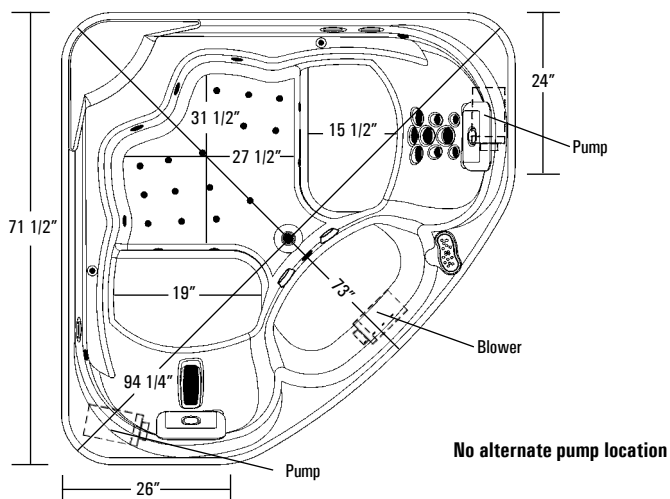

No alternate pump location available.

Overflow located underneath fill spout



* Available without fast-fill waterfall spout.

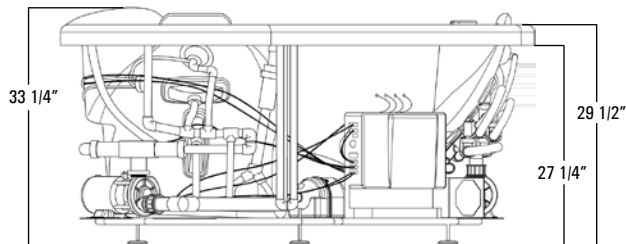

Bottom of base to middle of overflow: 25 7/8"

Rough-In Plumbing Measurements

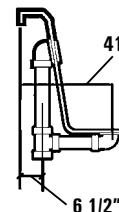

SPECIFICATIONS:

GENERAL SPECIFICATIONS:

Tub Size	71 1/2" x 71 1/2" x 33 1/4" 182 cm x 182 cm x 84 cm
Bathing Well	Lounge 1: 43" long Lounge 1: 19" wide Lounge 2: 47" long Lounge 2: 19" wide 24 3/4" interior depth 20 1/2" maximum water depth
Shipping Weight	862 lbs. / 391 kg
Tub Weight Filled	2965 lbs. / 1345 kg
Gallons to Overflow	192 gal. / 727 L
Gallons to Operate	1 bather: 170 gal. / 644 L 2 bathers: 151 gal. / 572 L

ELECTRICAL SPECIFICATIONS:

Electronic Control Package:
230V; 50 AMP w/ GFCI; 4-Wire w/ Dedicated Neutral

This unit is not recommended for shower installations.

This unit has a 3/4" female waterfall fill spout connection.

STANDARD EQUIPMENT:

- 24 Hydrotherapy Jets including:**
- 12 Shiatsu-Pro Neck and Back Jets
 - 2 Recessed Fan Jets
 - 4 Rotary Massage Foot Jets
 - 2 Rotary Massage Elite Knee Jets
 - 2 Pressure Plus Wrist Jets and 2 Pressure Plus Elbow Jets
- Air Bath System:**
- 1 HP Variable Speed Air Blower with 20-Minute Timer
 - Automatic Purge and Dry Cycle
 - 600 Watt Air Heating System
- Aquatic Quality Features:**
- Independent 2 HP, 3-Speed Run-Dry Pumps
 - Digital Electronic Control System
 - Shiatsu Electronic Control with Preprogrammed Jet Sequencer
 - Waterproof Universal Remote Control
 - 4 kW Inline Maintenance Heater
 - 2 Pulsating Neck Jet Pillows
 - Integrally Molded Fast-Fill Waterfall Spout/Optional
 - please specify on order (valves not included)
 - Bi-level Foot Rest
 - Chromatherapy
 - 2 Reclining Lounge Seats with Arm Rests
 - Adjusta-Level Base
 - "Quiet Pad" Anti-Vibration Pump Mounts
 - Heat-bent Rigid PVC Piping for Optimum Sanitary Conditions
 - Slip Resistant Floor
 - Durable, Easy to Clean, Lucite® Cast Acrylic Surface
 - Available in 8 Standard No-Charge Colors
- UL & IAPMO Listed, Factory Tested**
Limited Lifetime Warranty

OPTIONAL EQUIPMENT:

- Available without Fast-Fill Waterfall Spout
- See Price List for Details
- Jet Finish
 - Chrome, Polished Brass, Gold, Polished Nickel or Satin Nickel
- Lift & Turn Waste and Overflow
 - Chrome, Polished Brass, Gold, Polished Nickel, Satin Nickel, or Oil Rubbed Bronze
- Cable Drive Waste and Overflow
 - Chrome, Polished Brass, Gold, Polished Nickel, Satin Nickel, Oil Rubbed Bronze, or Color Matched (Bone, White, and Biscuit Only)
- Hand Held Jet - Chrome or Polished Brass
- Premium Colors

All acrylic colors featured by Aquatic match the industry's leading fixture manufacturers.

**Fax-On-Demand
Document # 1193**



MILLENNIUM 9

AQUATIC

MILLENNIUM SERIES MODEL # AI9MIL7700

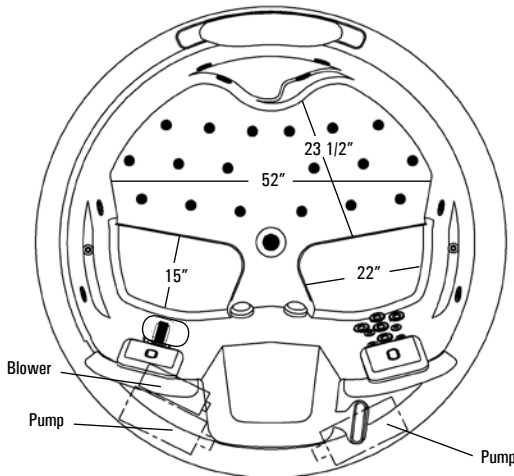

No alternate pump location available.

Overflow located underneath fill spout



*Available without fast-fill waterfall spout.

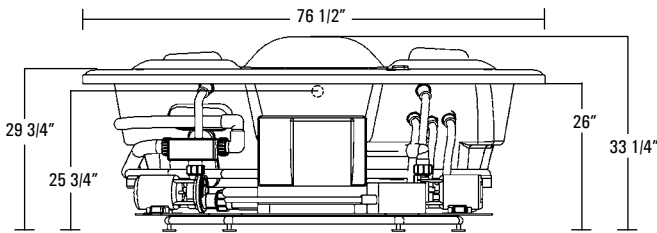

Rough-In Plumbing Measurements

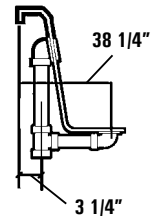

SPECIFICATIONS:

GENERAL SPECIFICATIONS:

Tub Size	76 1/2" diam. x 33 1/4" height 194 cm diam. x 84 cm height
Bathing Well	38 1/2" long 52" wide 25 1/4" interior depth
Shipping Weight	934 lbs. / 424 kg
Tub Weight Filled	2,189 lbs. / 993 kg
Gallons to Overflow	219 gal. / 829 L
Gallons to Operate	1 bather: 198 gal. / 750 L 2 bathers: 185 gal. / 700 L

ELECTRICAL SPECIFICATIONS:

Electronic Control Package:
230V; 50 AMP w/ GFCI; 4-Wire w/ Dedicated Neutral

This unit is not recommended for shower installations.

This unit has a 3/4" female waterfall fill spout connection.

STANDARD EQUIPMENT:

- 24 Hydrotherapy Jets including:**
- 12 Shiatsu-Pro Neck and Back Jets
 - 2 Recessed Fan Jets
 - 4 Rotary Massage Foot Jets
 - 2 Rotary Massage Elite Knee Jets
 - 2 Pressure Plus Wrist Jets and 2 Pressure Plus Elbow Jets
- Air Bath System:**
- 1 HP Variable Speed Air Blower with 20-Minute Timer
 - Automatic Purge and Dry Cycle
 - 600 Watt Air Heating System
- Aquatic Quality Features:**
- Independent 2 HP, 3-Speed Run-Dry Pumps
 - Digital Electronic Control System
 - Shiatsu Electronic Control with Preprogrammed Jet Sequencer
 - Waterproof Universal Remote Control
 - 4 kW Inline Maintenance Heater
 - 2 Pulsating Neck Jet Pillows
 - Integrally Molded Fast-Fill Waterfall Spout/Optional - please specify on order (valves not included)
 - Bi-level Foot Rest
 - Chromatherapy
 - 2 Reclining Lounge Seats with Arm Rests
 - Adjusta-Level Base
 - "Quiet Pad" Anti-Vibration Pump Mounts
 - Heat-bent Rigid PVC Piping for Optimum Sanitary Conditions
 - Slip Resistant Floor
 - Durable, Easy to Clean, Lucite® Cast Acrylic Surface
 - Available in 8 Standard No-Charge Colors
- UL & IAPMO Listed, Factory Tested**
Limited Lifetime Warranty

OPTIONAL EQUIPMENT:

- Available without Fast-Fill Waterfall Spout
- See Price List for Details
- Jet Finish
 - Chrome, Polished Brass, Gold, Polished Nickel or Satin Nickel
- Lift & Turn Waste and Overflow
 - Chrome, Polished Brass, Gold, Polished Nickel, Satin Nickel, or Oil Rubbed Bronze
- Cable Drive Waste and Overflow
 - Chrome, Polished Brass, Gold, Polished Nickel, Satin Nickel, Oil Rubbed Bronze, or Color Matched (Bone, White, and Biscuit Only)
- Hand Held Jet - Chrome or Polished Brass
- Premium Colors

All acrylic colors featured by Aquatic match the industry's leading fixture manufacturers.

Fax-On-Demand Document # 1194



The manufacturer accepts a 1/4" variance. There are variations on each tub and specifications are subject to change as we improve upon our product as required. The dimensions needed for site preparation and structure building should be measured from the tub; Aquatic Industries, Inc. assumes no responsibility for preparatory work. www.aquaticwhirlpools.com 800.555.5324

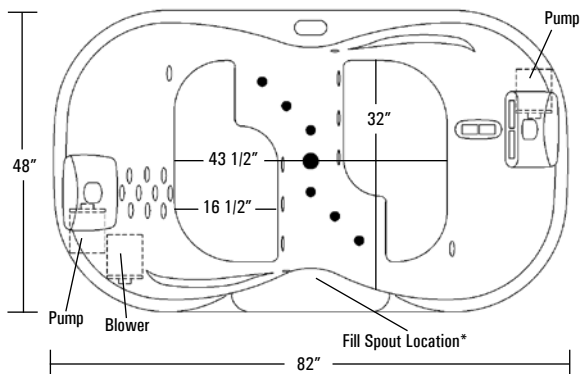

No alternate pump location available.



*Available without fast-fill waterfall spout.

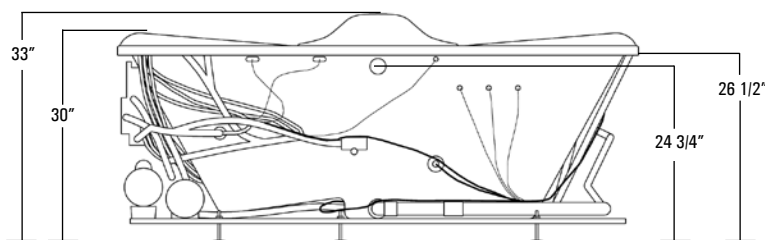

Rough-In Plumbing Measurements

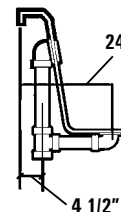

SPECIFICATIONS:

GENERAL SPECIFICATIONS:

Tub Size	82" x 48" x 33"
	208 cm x 122 cm x 84 cm
Bathing Well	Lounge 1 seat: 19" wide
	Lounge 1: 43 1/2" long
	Lounge 2 seat: 19" wide
	Lounge 2: 43 1/2" long
	32" wide
	24" interior depth
Maximum Water Depth	20"
Shipping Weight	740 lbs. / 336 kg
Tub Weight Filled	1473 lbs. / 670 kg
Gallons to Overflow	140 gal. / 529 L
Gallons to Operate	1 bather: 116 gal. / 438 L
	2 bathers: 92 gal. / 348 L

ELECTRICAL SPECIFICATIONS:

Electronic Control Package:
230V; 50 AMP w/ GFCI; 4-Wire w/ Dedicated Neutral

This unit is not recommended for shower installations.

This unit has a 3/4" male waterfall fill spout connection.

**Fax-On-Demand
Document # 1115**



STANDARD EQUIPMENT:

- 22 Hydrotherapy Jets including:**
- 12 Shiatsu-Pro Neck and Back Jets
 - 2 Recessed Fan Jets
 - 2 Rotary Massage Foot Jets with Footrest
 - 2 Rotary Massage Knee Jets
 - 2 Pressure Plus Wrist Jets and 2 Pressure Plus Elbow Jets

Air Bath System:

- 1 HP Variable Speed Air Blower with 20-Minute Timer
- Automatic Purge and Dry Cycle
- 600 Watt Air Heating System

Aquatic Quality Features:

- Independent 2 HP, 3-Speed Run-Dry Pumps
 - Digital Electronic Control System
 - Shiatsu Electronic Control with Preprogrammed Jet Sequencer
 - Waterproof Universal Remote Control
 - 4 kW Inline Maintenance Heater
 - 2 Pulsating Neck Jet Pillows
 - Integrally Molded Fast-Fill Waterfall Spout/Optional - please specify on order (valves not included)
 - Chromatherapy
 - 2 Reclining Lounge Seats with Arm Rests
 - Adjusta-Level Base
 - "Quiet Pad" Anti-Vibration Pump Mounts
 - Heat-bent Rigid PVC Piping for Optimum Sanitary Conditions
 - Slip Resistant Floor
 - Durable, Easy to Clean, Lucite® Cast Acrylic Surface
 - Available in 8 Standard No-Charge Colors
- UL & IAPMO Listed, Factory Tested
Limited Lifetime Warranty**

OPTIONAL EQUIPMENT:

- Available without Fast-Fill Waterfall Spout
- See Price List for Details
- Jet Finish
 - Chrome, Polished Brass, Gold, Polished Nickel or Satin Nickel
- Lift & Turn Waste and Overflow
 - Chrome, Polished Brass, Gold, Polished Nickel, Satin Nickel or Oil Rubbed Bronze
- Cable Drive Waste and Overflow
 - Chrome, Polished Brass, Gold, Polished Nickel, Satin Nickel, Oil Rubbed Bronze or Color Matched (Bone, White, and Biscuit Only)
- Hand Held Jet - Chrome or Polished Brass
- Premium Colors

All acrylic colors featured by Aquatic match the industry's leading fixture manufacturers.