

CENTURY 41

AQUATIC

CENTURY SERIES MODEL # AI7248RC41

Standard Pump Location

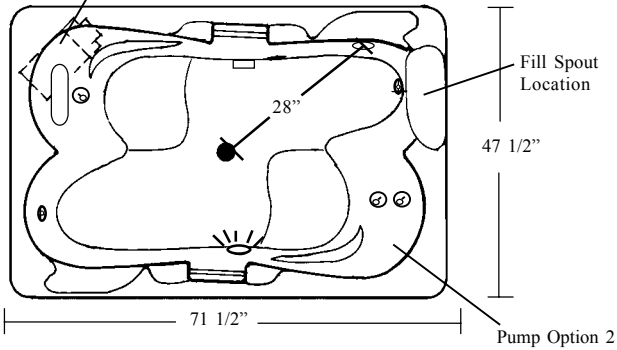



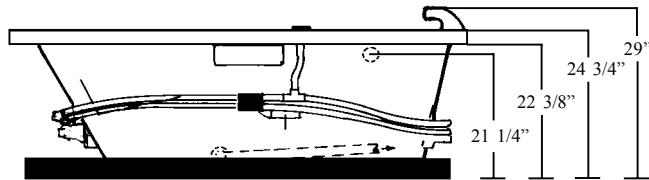

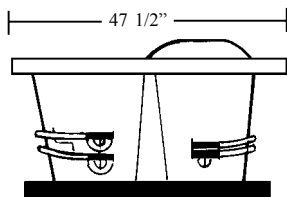
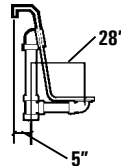

 Two Person Bath



Rough-In Plumbing Measurements



EQUIPMENT LEGEND

-  Drain
-  Pump Location
-  Fan Jet
-  Rotary Massage Jet
-  Full Size Pressure-Flo Hydrotherapy Jet
-  Chromatherapy Lighting

SPECIFICATIONS:

General Specifications:

Tub Size	71 1/2" x 47 1/2" x 29"
	182 cm x 121 cm x 74 cm
Bathing Well	48" long
	32" wide
	23" interior depth
Shipping Weight	276 lbs. / 125 kg
Tub Weight Filled	1350 lbs. / 612 kg
Gallons to Overflow	139 gal. / 526 L
Gallons to Operate	1 bather: 120 gal. / 454 L
	2 bather: 89 gal. / 337 L

Electrical Specifications:

Pump	2 HP; 11 AMP; 110V
Requirement	15 AMP; 110V, separate circuit required protected w/ Class A GFCI
Inline Heater	1.5 kW; 12 AMP; 110V
Requirement	15 AMP; 110V, separate circuit required protected w/ Class A GFCI

**This unit is not recommended for shower installations.*

This unit has a 3/4" male waterfall fill spout connection.

STANDARD EQUIPMENT:

- **8 Hydrotherapy Jets including:**
 - 3 Recessed Rotary Massage Jets
 - 2 Rotary Massage Foot Jets
 - 2 Full Size Pressure-Flo Hydrotherapy Jets
 - 1 Recessed Fan Jet
- **Aquatic Quality Features:**
 - 2 HP, 3-Speed Run-Dry Pump
 - Bath-Side Electronic Control Panel
 - Integrally Molded Fast-Fill Waterfall Spout (valves not included)
 - Chromatherapy LED Lighting
 - 1.5 kW Inline Maintenance Heater
 - "Quiet Pad" Anti-Vibration Pump Mount for Quiet Pump Operation
 - 2 Extra-Deep Contoured Lounges
 - 2 Acrylic Grab Bars
 - 2 Arm Rests
 - Slip Resistant Floor
 - Pre-levleed ABS Support Base
 - Heat-bent Rigid PVC Piping for Optimum Sanitary Conditions
 - Durable, Easy to Clean, Lucite® Cast Acrylic Surface
 - Available in 8 Standard No-Charge Colors
- **UL & IAPMO Listed, Factory Tested**
- **Limited 15 Year Warranty**

OPTIONAL EQUIPMENT:

- Comfort Pillow -- Oval or Rectangle
- Jet Finish
 - Chrome, Polished Brass, Gold, Polished Nickel or Satin Nickel
- Control Panel Trim
 - White, Chrome, Polished Brass, Satin Nickel, Polished Nickel, Oil Rubbed Bronze or Clear
- Lift & Turn Waste and Overflow
 - Chrome, Polished Brass, Gold, Polished Nickel or Satin Nickel
- Cable Drive Waste and Overflow
 - Chrome, Polished Brass, Gold, Polished Nickel, Satin Nickel or Color Matched (Bone, White & Biscuit Only)
- Hand Held Jet
- Decorative Rim Kit -- Chrome or Polished Brass
- Optional Pump Location
- Remote Pump Location
- Premium Colors

All acrylic colors featured by Aquatic match the industry's leading fixture manufacturers.

Fax-On-Demand Document # 1025



The manufacturer accepts a 1/4" variance. There are variations on each tub and specifications are subject to change as we improve upon our product as required. The dimensions needed for site preparation and structure building should be measured from the tub; Aquatic Industries, Inc. assumes no responsibility for preparatory work.